

#1 Pt 1

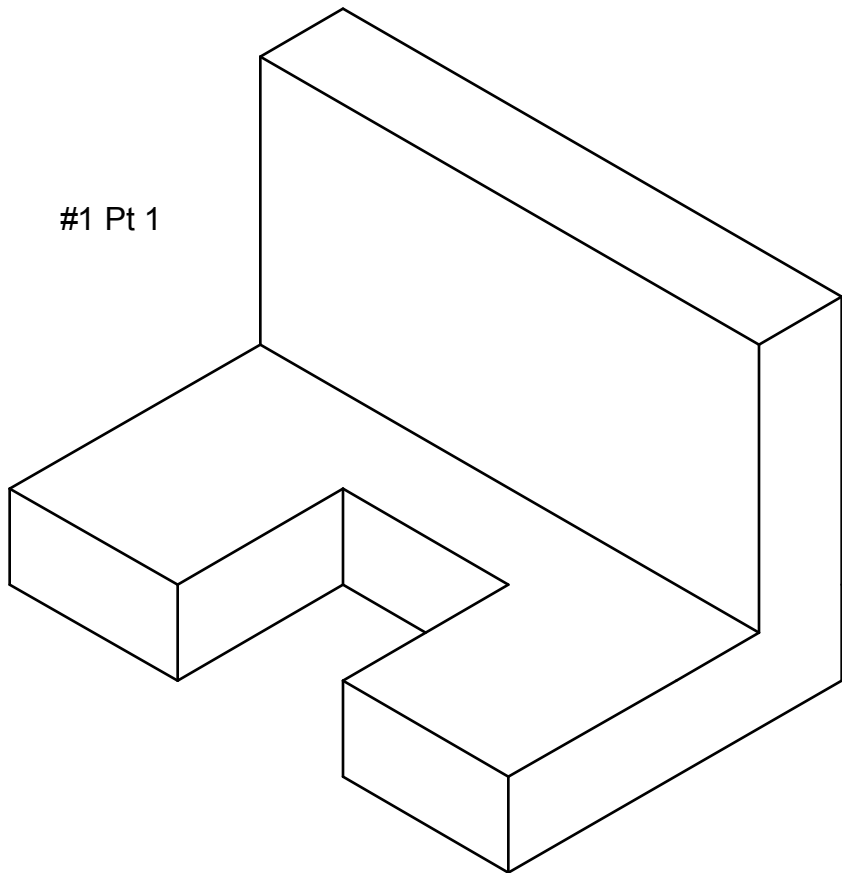

#2 Pt 1

